

*Terrace 44 485130*  
*Art.Nr. 443400*

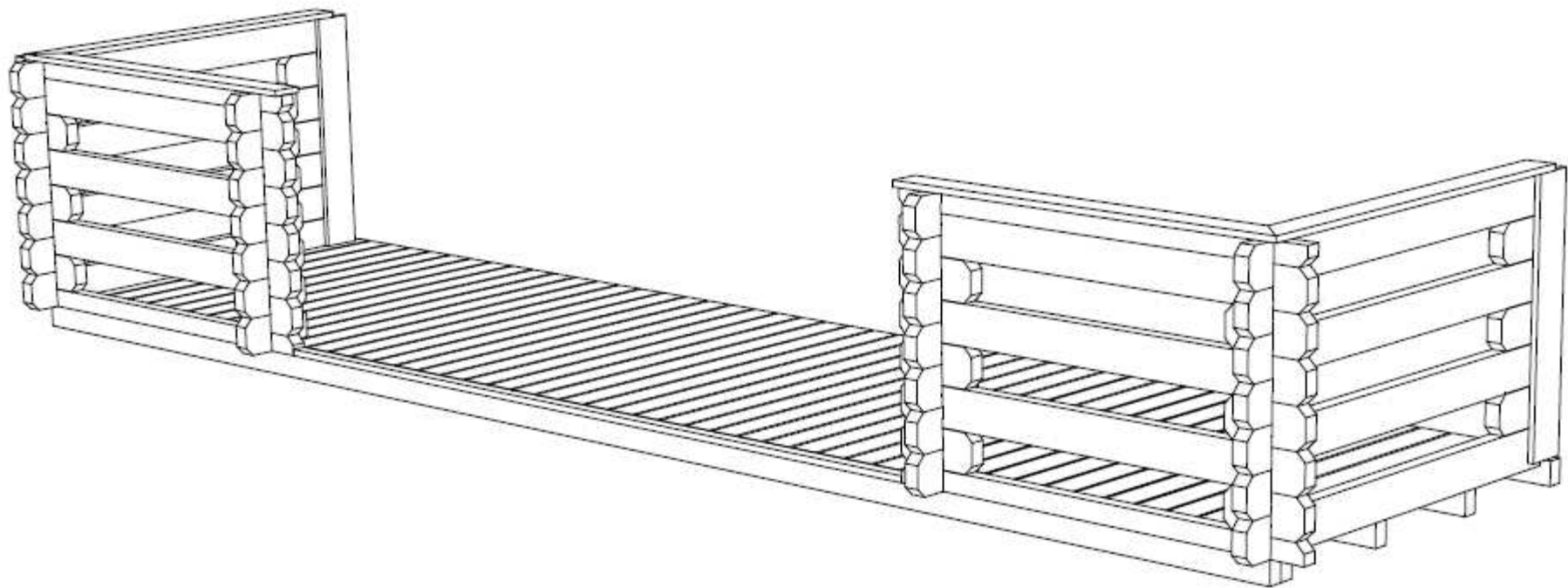

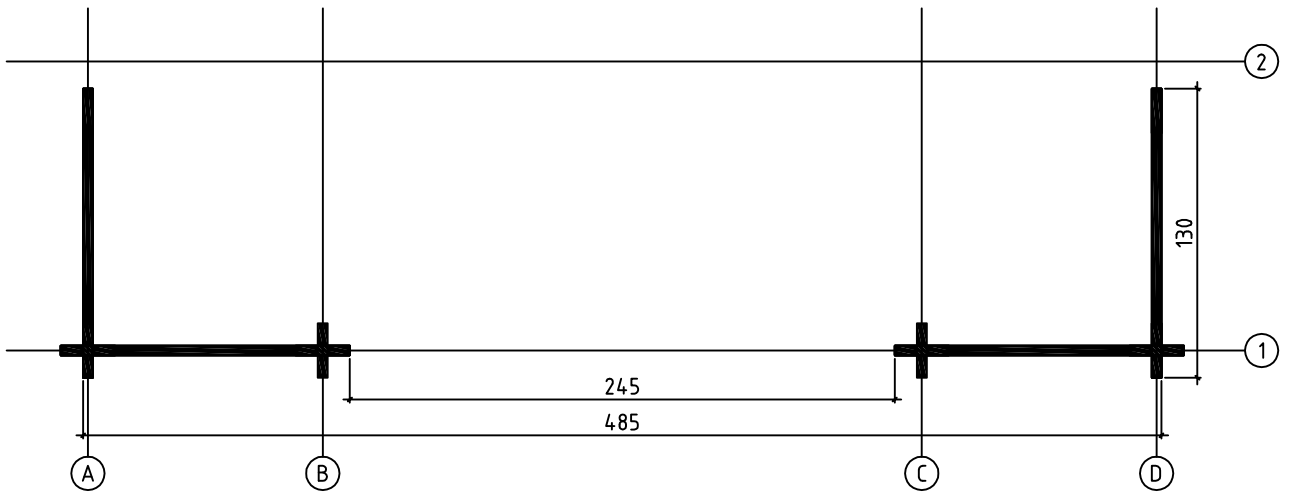

GROUNDPLAN - GRUNDPLAN - PLAN DE MASSE

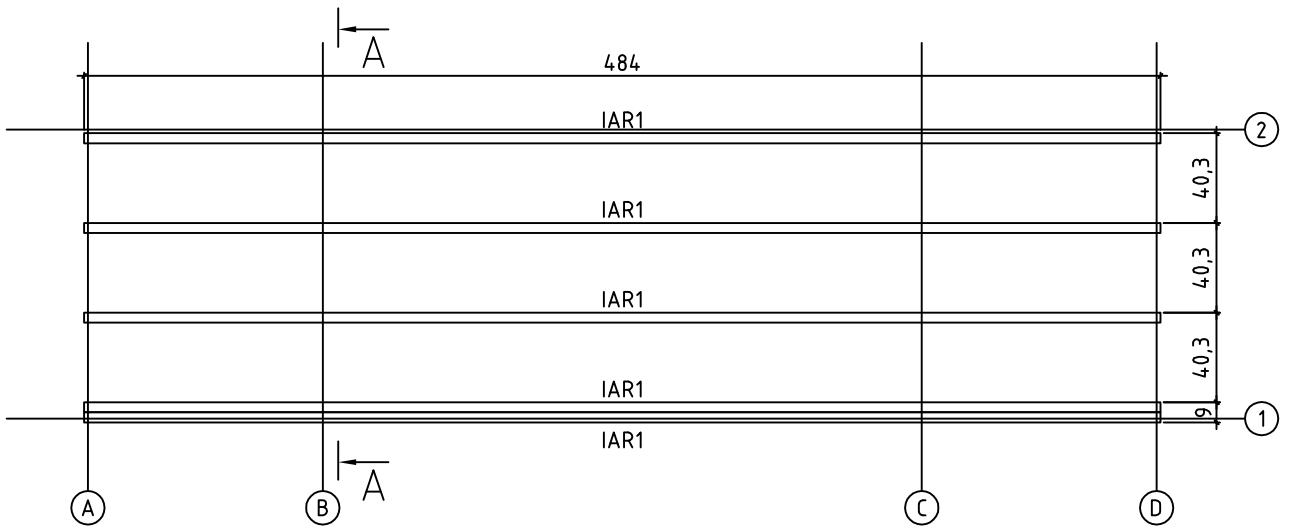

FOUNDATION - FUNDAMENT - FONDATION

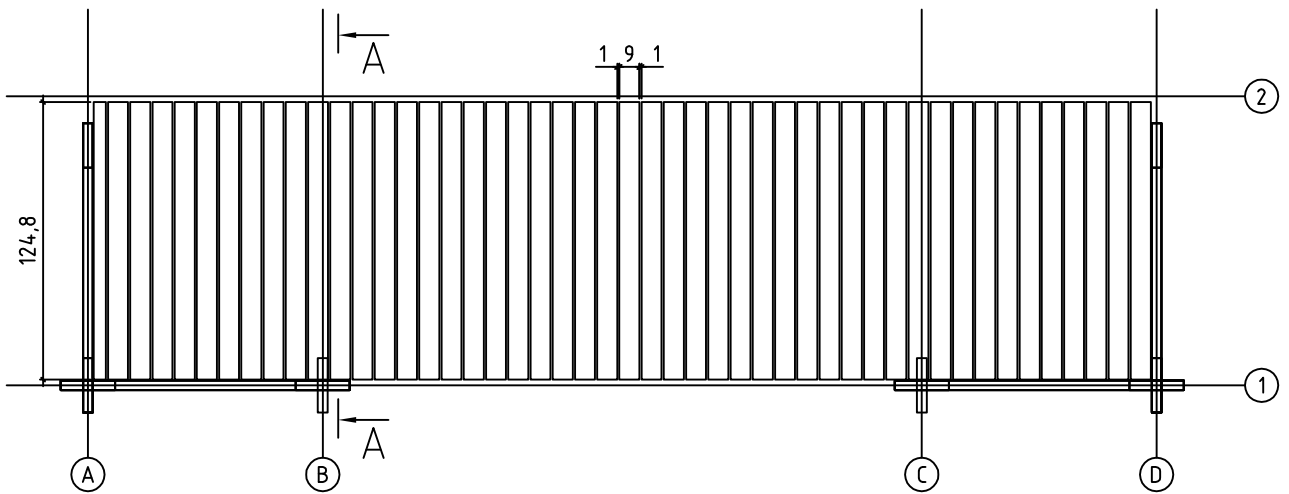

TERRACE BOARDS - TERRASSENBRETTEN - PLANCHER DE TERRASSE

Front view - Vorderansicht - Élévation avant

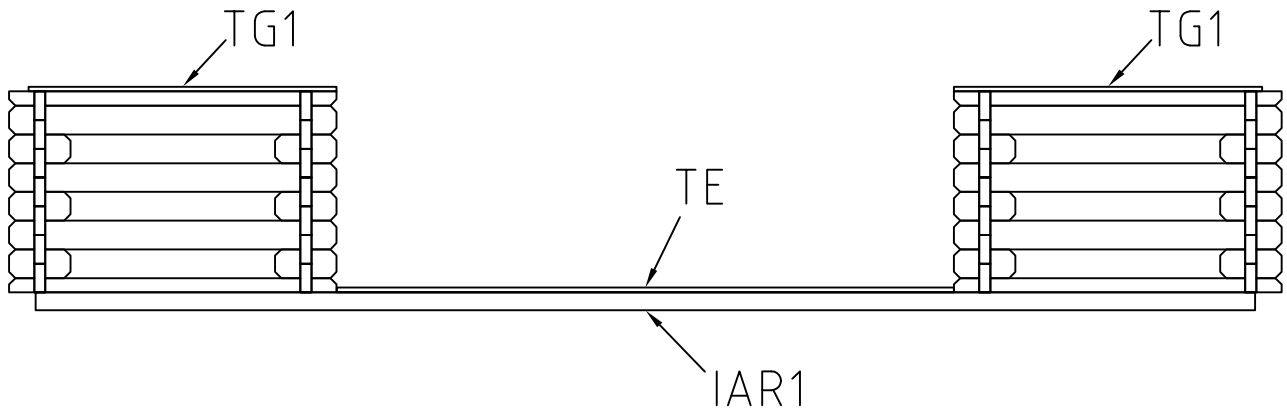

Side view - Seitenansicht - Élévation principale

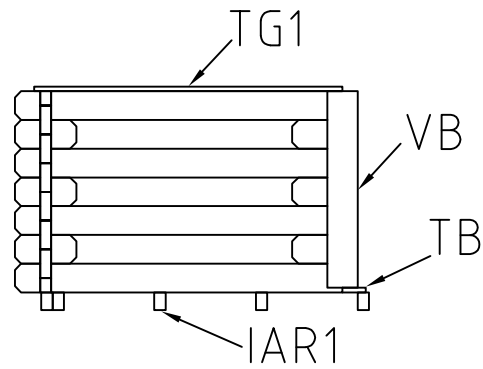



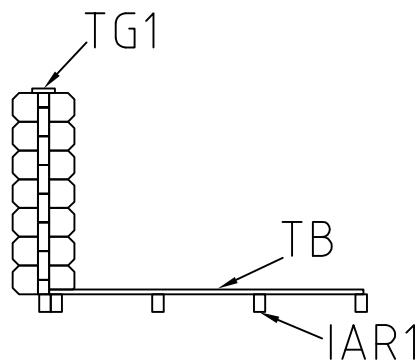



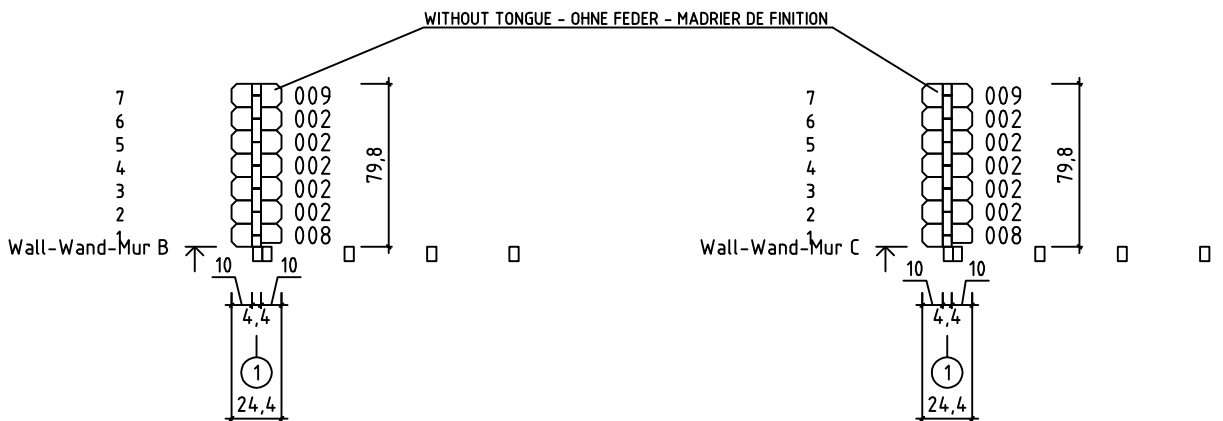
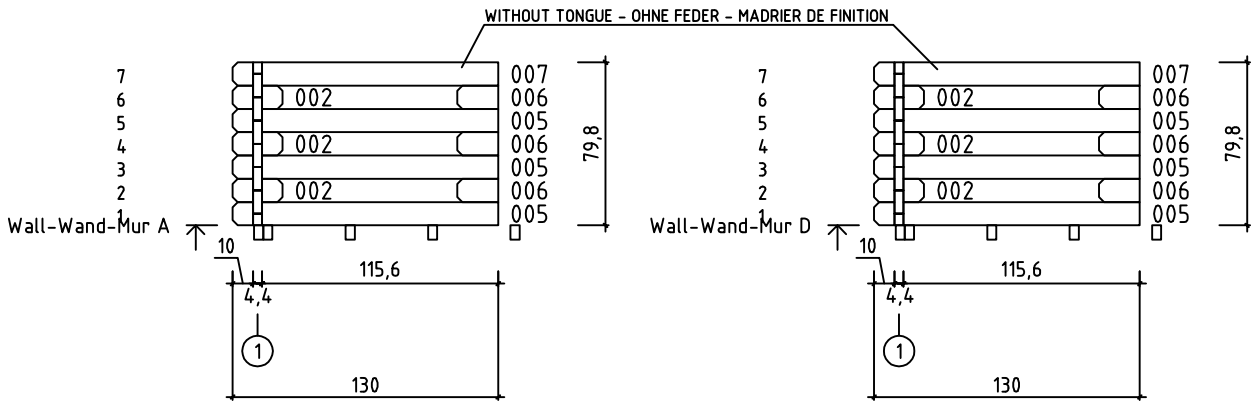
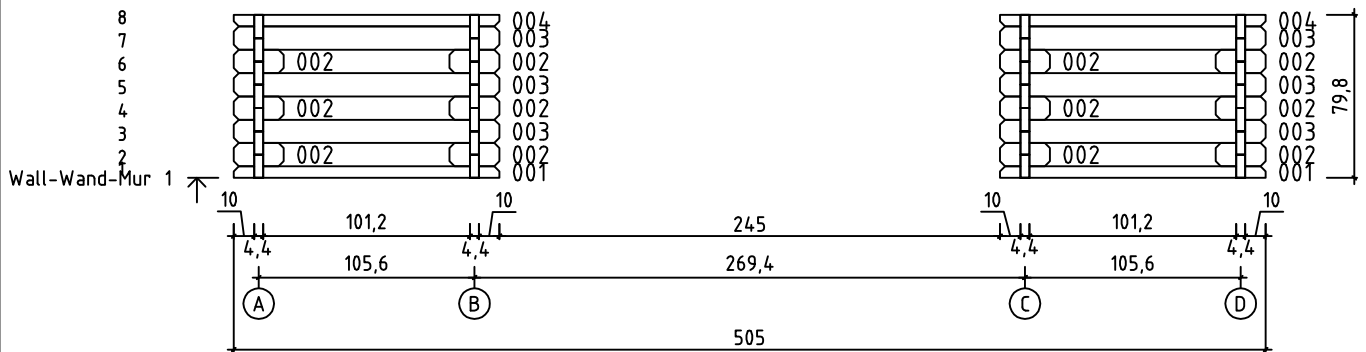

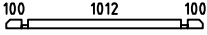

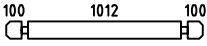
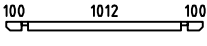
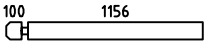

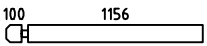
Section - Schnitt - Coupe A-A

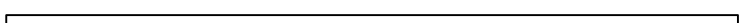
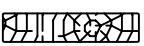

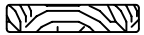
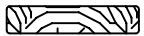
Art.Nr. 443400

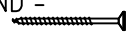

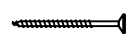
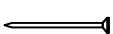
Pos	24.01.2011	Piecelist - Stücklist - Liste des composants Art.Nr. 443400	5/5	Q.	P. (mm)	L. (mm)
001				2	44x57	1300
002				28	44x114	244
003				6	44x114	1300
004				2	44x57	1300
005				6	44x114	1300
006				6	44x114	200
007				2	44x114	1300
008				2	44x114	244
009				2	44x114	244
IAR1	FOUNDATION - FUNDAMENT - FONDATION					
				5	45x70	4840
TB	TERRACE BOARDS - TERRASSENBRETT - PLANCHER DE TERRASSE			48	90x19	1248
TE	TERRACE EDGE BOARD - TERRASSENBRETT, EINGANG - LAME DE SEUIL D'ENTREE DE TERRASSE			1	19x44	2448
TG1	GUARD-RAIL FOR TERRACE - TERRASSENGELÄNDER - MAIN COURANTE DE TERRASSE			4	18x90	1223
VB	TERRACE JOIT BOARDS - VERBINDUNGSBRETT - PROFIL DE JONCTION POUR FIXER LA TERRASSE AU MUR			4	18x120	779
	SCREW FOR TERRACE JOINT BOARDS - SCHRAUBEN FÜR VERBINDUNGSBRETT - VIS DE FIXATION PROFIL DE JONCTION TERRASSE			20	3.5x50	
	SCREWS FOR TERRACE EDGE BOARD - SCHRAUBEN FÜR EINGANG, TERRASSENBRETT - VIS DE FIXATION DE LAME DE SEUIL D'ENTREE DE TERRASSE			7	4x40	
	SCREW FOR TERRACE REAR BOARDS - SCHRAUBEN FÜR TERRASSENRAND - VIS DE FIXATION POUR MAIN COURANTE DE TERRASSE			16	4x40	
	SCREW FOR 1. WALL BEAM - SCHRAUBE FÜR 1. BOHLENREIHE - VIS DE FIXATION DES FONDATIONS			4	5x150	
	SCREW FOR 1. WALL BEAM - SCHRAUBE FÜR 1. BOHLENREIHE - VIS DE FIXATION DES FONDATIONS			11	5x90	
	ZN NAIL FOR TERRACE - ZN NÄGEL FÜR TERRASSENBRETT - POINTE POUR PLANCHER DE TERRASSE			384	2.1x50	